

RESMED

Swift™ FX Bella Gray

+ Swift™ FX HEADGEAR

NASAL PILLOWS SYSTEM

User Guide

English



Did you know?

Replacing your mask and supplies is one of the most important steps in maintaining effective therapy.

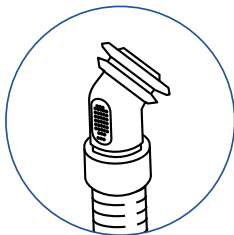

Replace when...

- The cushion is discolored.
- The cushion is cracked, torn or damaged in any way.
- The headgear is stretched and needs to be tightened more than when it was new.

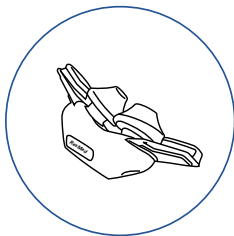

What to do...

Consult your equipment provider to learn what replacement schedule may be available through your insurance policy.

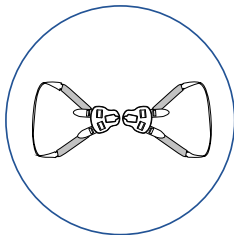

RESMED

Rx Only

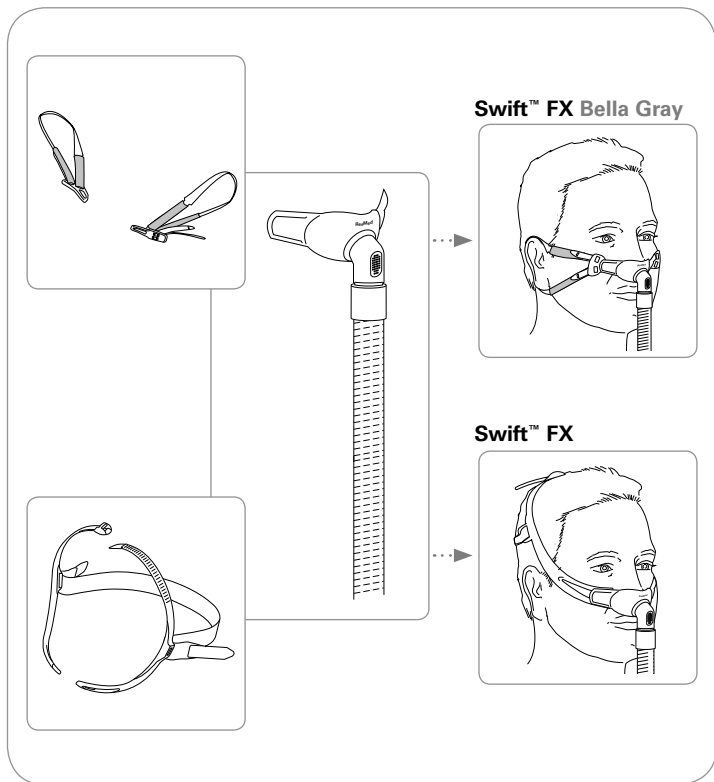

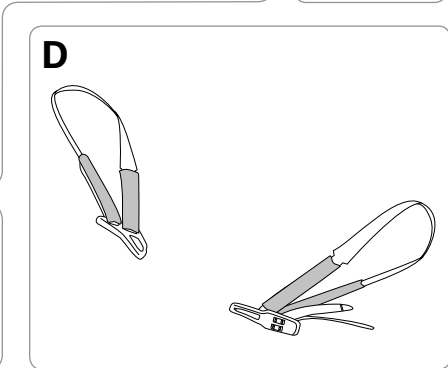
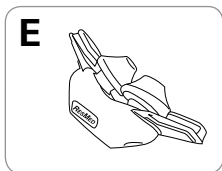
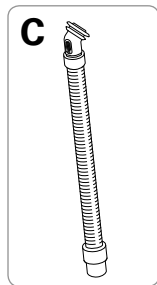
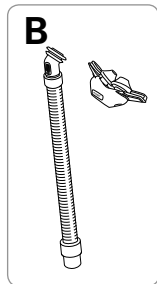
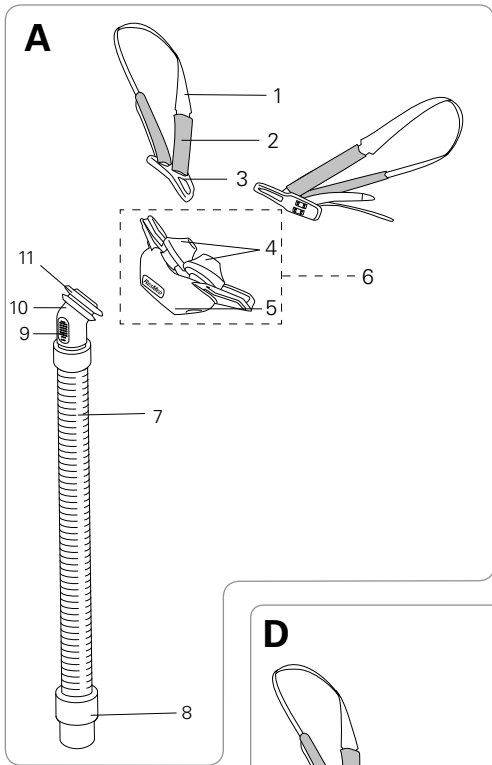

Mask components / Composants du masque / Piezas de la mascarilla / Componentes da máscara

Item / Article / Artículo / Item	Description / Description / Descripción / Descrição	Part number / Code produit / Número de pieza / Código do produto
1	Strap / Sangle / Correa / Correia	—
2	Soft sleeve / Gaine souple / Funda blanda / Luva maleável	—
3	Buckle / Boucle / Hebilla / Fivela	—
4	Nasal pillows / Masque narinaire / Almohadillas nasales / Almofadas nasais	—
5	Cushion / Bulle / Almohadilla / Almofada	—
6	Pillows / Coussins / Almohadillas / Almofadas	—
7	Short tube / Tuyau court / Tubo corto / Tubo curto	—
8	Swivel / Pièce pivotante / Peça giratoria / Peça giratória	—
9	Vent / Orifice de ventilation / Ventilación / Respiradouro	—
10	Elbow / Coude / Codo / Cotovelo	—
11	Swivel ring / Anneau pivotant / Aro de la pieza giratoria / Anel da peça giratória	—
A	Swift FX Bella Gray complete system / Masque Swift FX Bella Gray complet / Sistema completo Swift FX Bella Gray / Sistema completo da Swift FX Bella Gray	61568
B	Pillows system (Frame system) / Coussins (support complet) / Sistema de almohadillas (Sistema de armazón) / Sistema de almofadas (sistema da armação)	61510 (XS) 61511 (S) 61512 (M) 61513 (L)
C	Short tube assembly (Frame assembly) / Ensemble tuyau court (ensemble support) / Conjunto del tubo corto (Sistema de armazón) / Conjunto de tubo curto (conjunto da armação)	61528 (1) 61527 (10)

D	Swift FX Bella Gray headgear assembly / Ensemble harnais du Swift FX Bella Gray / Conjunto del arnés Swift FX Bella Gray / Conjunto do arnês da Swift FX Bella Gray	61582 (1)
E	Pillows / Coussins / Almohadillas / Almofadas	61521 (S) 61522 (M) 61523 (L)
Also available / Également disponible / También disponible / Também disponível		
	Pillows / Coussins / Almohadillas / Almofadas	61520 (XS)
	Swift FX Bella Gray + Swift FX headgear (Combination pack) / Harnais Swift FX et Bella Swift FX (Ensemble) / Arnés Swift FX Bella Gray + Swift FX (paquete combinado) / Arnês da Swift FX Bella Gray e da Swift FX (pacote combinado)	61583

XS: Extra Small / Très petit / Extra-pequeno / Extra Pequeno

S: Small / Petit / Pequeño / Pequeno

M: Medium / Moyen / Mediano / Médio

L: Large / Grand / Grande / Grande

Fitting / Mise en place / Colocación / Colocação

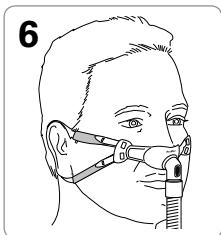
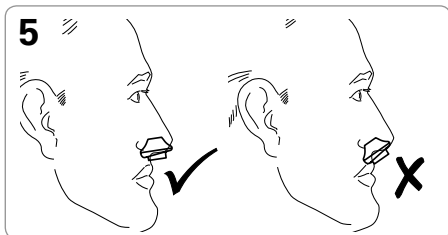
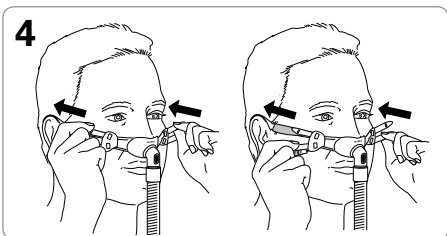
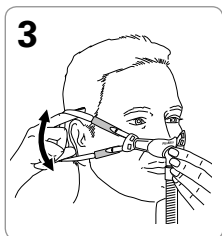
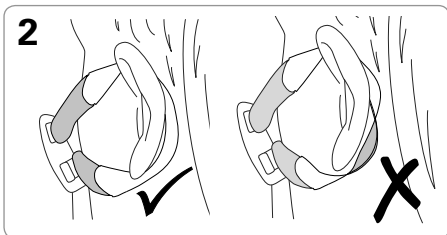
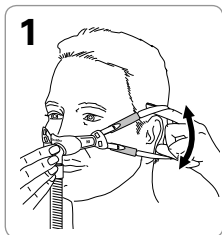

Disassembly / Démontage / Desmontaje / Desmontagem

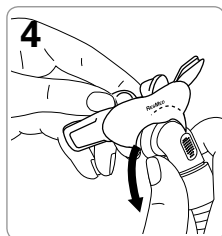
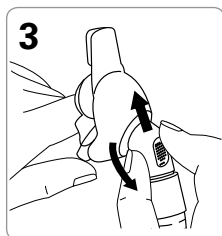
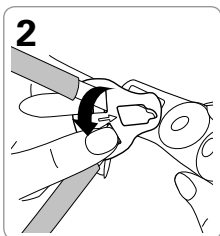
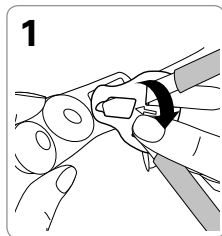

Reassembly / Remontage / Montage / Remontagem

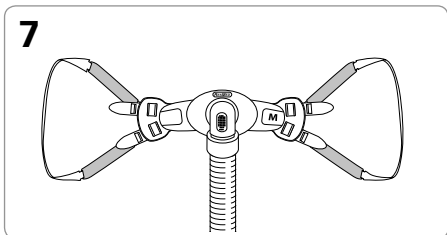
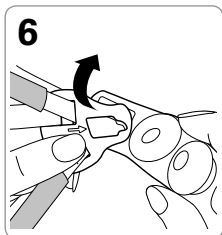
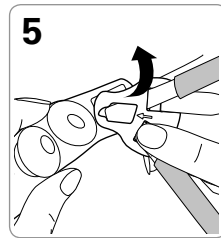
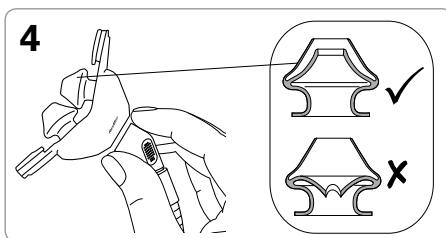
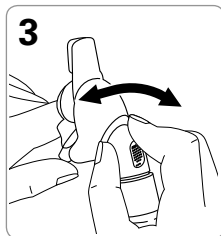
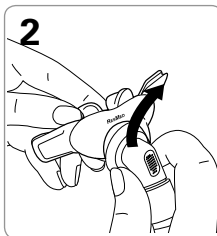
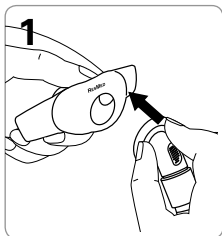

Reassembly of straps (if required) / Remontage des sangles (le cas échéant) / Montaje de las correas (de ser necesario) / Remontagem das correias (se necessário)

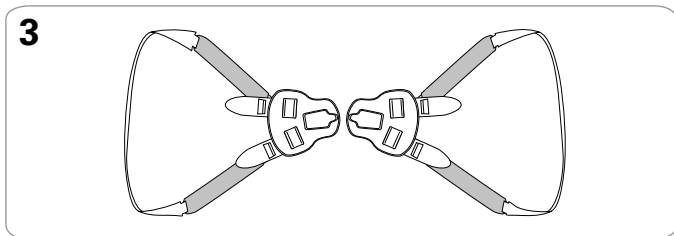
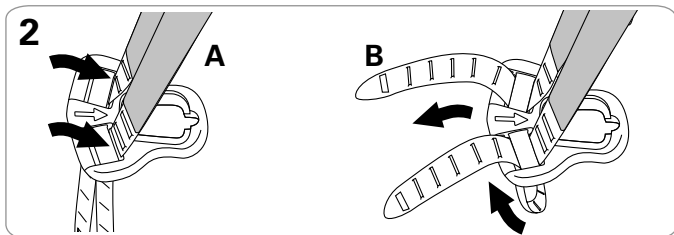
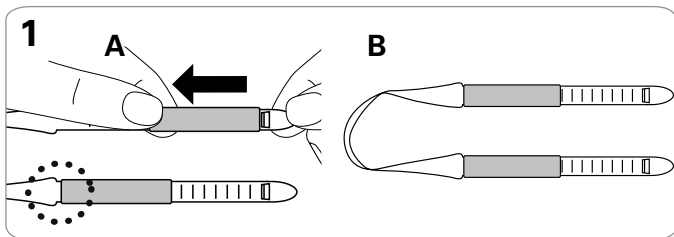

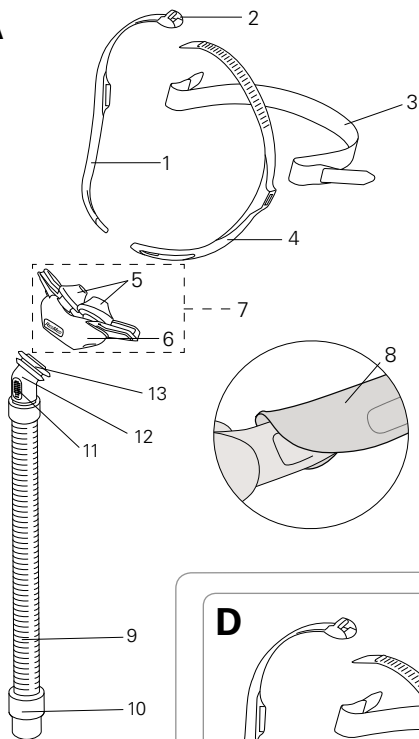
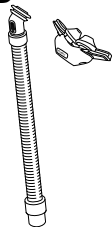
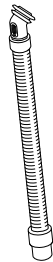
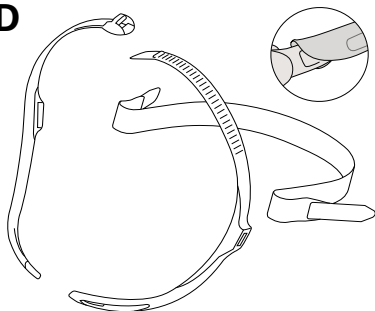
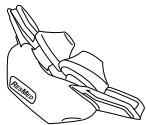
A**B****C****D****E**

Mask components / Composants du masque / Piezas de la mascarilla / Componentes da máscara

Item / Article / Artículo / Item	Description / Description / Descripción / Descrição	Part number / Code produit / Número de pieza / Código do produto
1	Headgear right / Harnais droit / Arnés derecho / Lateral direita do arnés	—
2	Top buckle / Boucle supérieure / Hebilla superior / Fivela superior	—
3	Back strap (1 x P) / Sangle arrière (1 x R) / Correa posterior (1 x R) / Correia traseira (1 x R)	—
4	Headgear left / Harnais gauche / Arnés izquierdo / Lateral esquerda do arnés	—
5	Nasal pillows / Masque narinaire / Almohadillas nasales / Almofadas nasais	—
6	Cushion / Bulle / Almohadilla / Almofada	—
7	Pillows / Coussins / Almohadillas / Almofadas	—
8	Soft wraps / Housses souples / Fundas blandas / Envoltórios macios	61530 (2)
9	Short tube / Tuyau court / Tubo corto / Tubo curto	—
10	Swivel / Pièce pivotante / Pieza giratoria / Peça giratória	—
11	Vent / Orifice de ventilation / Ventilación / Respiradouro	—
12	Elbow / Coude / Codo / Cotovelo	—
13	Swivel ring / Anneau pivotant / Aro de la pieza giratoria / Anel da peça giratória	—
A	Swift FX complete system / Masque Swift FX complet / Sistema completo Swift FX / Sistema completo da Swift FX	61500

B	Pillows system (Frame system) / Coussins (support complet) / Sistema de almohadillas (Sistema de armazón) / Sistema de almofadas (sistema da armação)	61510 (XS) 61511 (S) 61512 (M) 61513 (L)
C	Short tube assembly (Frame assembly) / Ensemble tuyau court (ensemble support) / Conjunto del tubo corto (Sistema de armazón) / Conjunto de tubo curto (conjunto da armação)	61528 (1) 61527 (10)
D	Swift FX headgear assembly / Ensemble harnais du Swift FX / Conjunto del arnés Swift FX / Conjunto do arnês da Swift FX	61529
E	Pillows / Coussins / Almohadillas / Almofadas	61520 (XS) 61521 (S) 61522 (M)
Also available / Également disponible / También disponible / Também disponível		
	Pillows / Coussins / Almohadillas / Almofadas	61520 (XS)
	Swift FX Bella Gray + Swift FX headgear (Combination pack) / Harnais Swift FX et Bella Swift FX (Ensemble) / Arnés Swift FX Bella Gray + Swift FX (paquete combinado) / Arnês da Swift FX Bella Gray e da Swift FX (pacote combinado)	61583

XS: Extra Small / Très petit / Extra-pequeno / Extra Pequeno

S: Small / Petit / Pequeño / Pequeno

M: Medium / Moyen / Mediano / Médio

L: Large / Grand / Grande / Grande

Fitting / Mise en place / Colocación / Colocação

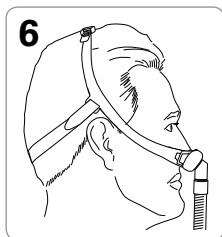
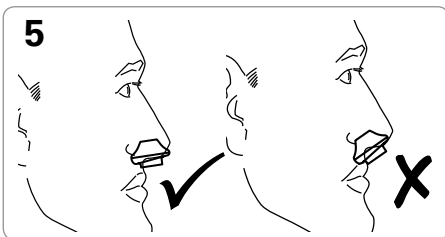
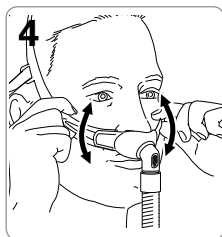
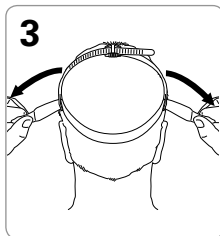
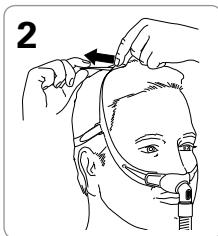

Disassembly / Démontage / Desmontaje / Desmontagem

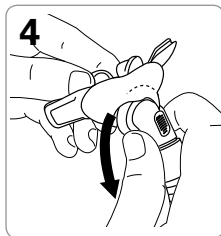
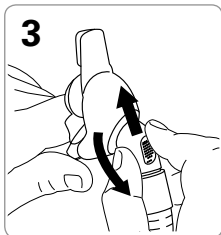
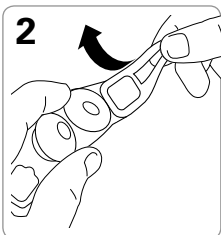
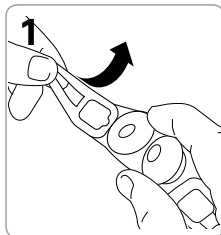

Reassembly

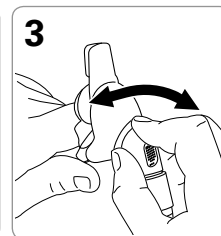
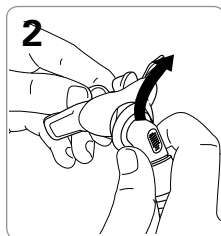
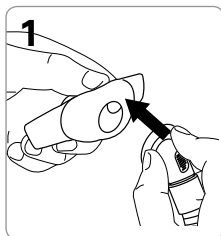

Reassembly / Remontage / Montaje / Remontagem

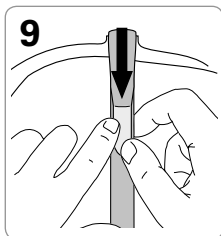
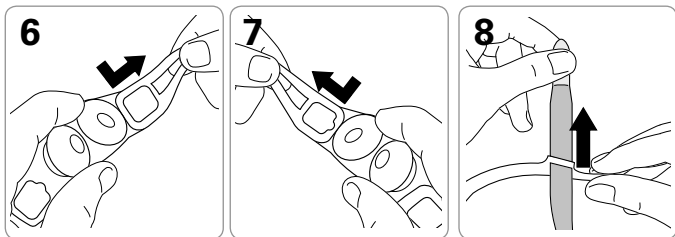
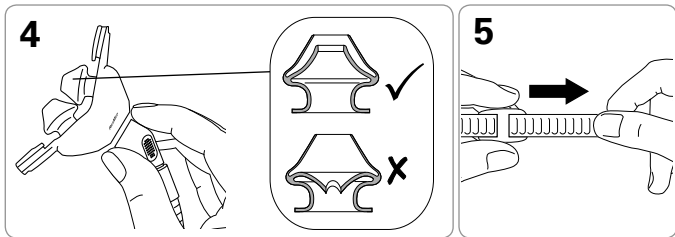

English

Swift™ FX Bella Gray

+ Swift™ FX HEADGEAR NASAL PILLOWS SYSTEM

Thank you for choosing the Swift FX Bella Gray + Swift FX Headgear. The Swift FX Bella Gray + Swift FX Headgear is the first of ResMed's Nasal Pillows Systems that offers a choice of two different types of headgear. This user guide provides you with instructions for setting up and using both headgear with your nasal pillows system.

Intended use

The Swift FX Bella Gray and Swift FX channels airflow noninvasively to a patient from a positive airway pressure (PAP) device such as a continuous positive airway pressure (CPAP) or bilevel system.

The Swift FX Bella Gray and Swift FX are:

- to be used by adult patients (> 66 lb/30 kg) for whom positive airway pressure has been prescribed
- intended for single-patient re-use in the home environment and multipatient re-use in the hospital/institutional environment.

Using your mask

When using your mask with ResMed CPAP or bilevel devices that have mask setting options, refer to the Technical specifications section in this user guide for mask selection options.

For a full list of compatible devices for these masks, see the Mask/Device Compatibility List on www.resmed.com on the **Products** page under **Service & Support**. If you do not have internet access, please contact your ResMed representative.

Notes:

- *These masks are not compatible for use with ResMed AutoSet CS™ 2 and VPAP™ Adapt SV devices.*
- *SmartStop may not operate effectively when using these masks with some CPAP or bilevel devices that have this feature.*
- *If you experience nasal dryness or irritation, use of a humidifier is recommended.*



GENERAL WARNINGS

- The vent holes must be kept clear.
- The mask should only be used with CPAP or bilevel devices recommended by a physician or respiratory therapist.
- The mask should not be used unless the device is turned on. Once the mask is fitted, ensure the device is blowing air.

Explanation: CPAP and bilevel devices are intended to be used with special masks (or connectors) which have vent holes to allow continuous flow of air out of the mask. When the device is turned on and functioning properly, new air from the device flushes the exhaled air out through the mask vent holes. However, when the device is not operating, insufficient fresh air will be provided through the mask, and the exhaled air may be rebreathed. Rebreathing of exhaled air for longer than several minutes can, in some circumstances, lead to suffocation. This applies to most models of CPAP or bilevel devices.

- Follow all precautions when using supplemental oxygen.
- Oxygen flow must be turned off when the CPAP or bilevel device is not operating, so that unused oxygen does not accumulate within the CPAP or bilevel device enclosure and create a risk of fire.
- Oxygen supports combustion. Oxygen must not be used while smoking or in the presence of an open flame. Only use oxygen in well ventilated rooms.
- At a fixed rate of supplemental oxygen flow, the inhaled oxygen concentration varies, depending on the pressure settings, patient breathing pattern, mask, point of application and leak rate. This warning applies to most types of PAP devices.

- The technical specifications of the mask are provided for your clinician to check that they are compatible with the CPAP or bilevel device. If used outside specification or if used with incompatible devices, the seal and comfort of the mask may not be effective, optimum therapy may not be achieved, and leak, or variation in the rate of leak, may affect the CPAP or bilevel device function.
- Discontinue using the mask if you have ANY adverse reaction to the use of the mask, and consult your physician or sleep therapist.
- Using a mask may cause tooth, gum or jaw soreness or aggravate an existing dental condition. If symptoms occur, consult your physician or dentist.
- As with all masks, some rebreathing may occur at low CPAP pressures.
- Refer to your CPAP or bilevel device manual for details on settings and operational information.
- Remove all packaging before using the mask.

Fitting

The Swift FX Bella Gray fitting illustrations in this user guide show the sequence for obtaining the best fit and comfort when using your mask.

Fitting steps

1. Hold the pillows at your nose ensuring that the ResMed logo is on the top of the pillows facing up. Pull one strap around and behind your ear.
2. Ensure the strap lies flat and is not twisted.
3. Repeat steps 1 and 2 with the other strap.
4. Adjust the mask fit by pulling the upper straps along the notches until a comfortable fit is achieved. Repeat with the lower straps. Do not overtighten.
5. Check that the nasal pillows are positioned upright in the entrance of your nostrils.
6. Finally, connect the free end of the short tube assembly to the device air tubing. The mask is now fitted and ready for use.



WARNING

Using Swift FX Bella Gray may cause ear soreness. If symptoms occur, consult your physician.

Removing your mask

To remove your mask, place your fingers underneath the straps and lift them away from your ears.

Disassembly

Refer to the Swift FX Bella Gray disassembly illustrations in this user guide.

Disassembly steps

- 1–2. Remove each buckle by slightly twisting the buckle and pulling away from the node on the pillows.
- 3–4. Gently push the swivel ring up and pull out of the cushion.

Note: *The strap and soft sleeve are not intended to be disassembled and can be washed together, while attached to the buckle.*

Reassembly

Refer to the Swift FX Bella Gray reassembly illustrations in this user guide.

System reassembly steps

- 1–2. Insert the swivel ring into the opening of the cushion. Ensure that the cushion sits between the ridges of the swivel ring.
3. Rotate the elbow to ensure it moves freely.
4. Check that the inner walls of the nasal pillows are not compressed or collapsed. If so, squeeze each nasal pillow to release the inner wall.
5. Hold the buckle with the arrow facing you. Latch the buckle onto the node on the pillows.
6. Repeat step 5 with the other buckle.

Headgear reassembly steps (if required)

If you have disassembled your headgear it needs to be reassembled before attaching to the pillows.

1. Thread each strap through the soft sleeve. Pull the soft sleeve up until it sits flush against the widest part of the strap. Ensure the soft sleeve lies flat on the strap.
2. Hold the buckle with the arrow facing up.
 - A. Ensuring the notches of the strap are facing the arrow head, thread the end of the strap down through the opening closest to the arrow head on the buckle.
 - B. Bring the end of the strap up through the other opening, making sure that the notches on the strap sit against each other.Repeat these steps with each strap.
3. Ensure that the straps are not twisted.

Fitting

The Swift FX fitting illustrations in this user guide show the sequence for obtaining the best fit and comfort when using your mask.

Fitting steps

1. Hold the pillows at your nose ensuring that the ResMed logo is on the top of the pillows facing up. Pull the headgear over your head. The headgear should sit midway between the ears and eyes.
2. Adjust the top straps by pulling the strap through the buckle, one notch at a time. Do not overtighten.
3. Adjust the side straps until a comfortable fit is achieved. The back strap can be positioned over or under the hair.
4. Adjust the headgear until the nasal pillows sits comfortably in your nose.
5. Check that the nasal pillows are positioned upright in the entrance of your nostrils.

6. Finally, connect the free end of the short tube assembly to the device air tubing.

The mask is now fitted and ready for use.

Removing your mask

To remove your mask loosen the upper strap, then pull the mask and headgear up over your head.

Disassembly

Refer to the Swift FX disassembly illustrations in this user guide.

Disassembly steps

- 1–2. Remove the headgear by slightly twisting each headgear arm and pulling away from the node on the pillows.
- 3–4. Gently push the swivel ring up and pull out of the cushion.

Reassembling

Refer to the Swift FX reassembly illustrations in this user guide.

Reassembly steps

- 1–2. Insert the swivel ring into the opening of the cushion. Ensure that the cushion sits between the ridges of the swivel ring.
3. Rotate the elbow to ensure it moves freely.
4. Check that the inner walls of the nasal pillows are not compressed or collapsed. If so, squeeze each nasal pillow to release the inner wall.
5. Thread the headgear strap through the top buckle.
6. Hold the headgear arm with the recess facing you. Latch the headgear arm onto the node on the pillows.
7. Repeat step 6 with the other headgear arm.
- 8–9. Thread the back strap through each side of the headgear, then fold over to secure. Ensure that the hook tab is on the outside.

Cleaning your mask in your home

Your mask and headgear should only be handwashed by gently rubbing in warm (approximately 86°F/30°C) water using mild soap. All components should be rinsed well with drinking quality water and allowed to air dry out of direct sunlight.



WARNING

Do not use aromatic-based solutions or scented oils (eg, eucalyptus or essential oils), bleach, alcohol or products that smell strongly (eg, citrus) to clean any of the mask components. Residual vapours from these solutions can be inhaled if not rinsed thoroughly. They may also damage the mask, causing cracks.



CAUTION

- If any visible deterioration of a system component is apparent (cracking, crazing, tears or cushion damage), the component should be discarded and replaced.
- Avoid connecting flexible PVC products (eg, PVC tubing) directly to any part of the mask. Flexible PVC contains elements that can be detrimental to the materials of the mask, and may cause the components to crack or break.

Daily/After each use:

- To optimize the mask seal, facial oils should be removed from the cushion after use.
- Handwash the separated mask components (excluding headgear).
- If the vent requires cleaning use a soft bristle brush.

Weekly:

- Handwash the headgear. It may be washed without being disassembled.

Reprocessing the mask between patients

This mask should be reprocessed when used between patients. Cleaning, disinfection and sterilization instructions are available from the ResMed website, www.resmed.com/masks/sterilization/americas. If you do not have internet access, please contact your ResMed representative.

Troubleshooting

Problem / possible cause

Solution

Pillows won't seal properly, are uncomfortable or cause red marks

Pillows may have been fitted incorrectly, adjusted incorrectly or the headgear is too tight.

Check that the ResMed logo on top of the pillows is facing outwards. Carefully follow the fitting instructions. Readjust the headgear to ensure it is not over tightened.

Inner wall position of one or both pillows is incorrect.

Squeeze pillow sides to release inner wall. The correct position is shown in the reassembly instructions.

Pillows are the wrong size.

Talk to your clinician.

Pillows may be dirty.

Clean pillows according to the instructions.

Mask is too noisy

System is assembled incorrectly.

Disassemble the mask, then reassemble according to the instructions.

System is leaking air.

Refit or reposition you mask. Adjust your headgear. Check your mask is assembled correctly.

Vent is blocked or partially blocked.

If the vent requires cleaning, use a soft bristle brush.

Problem / possible cause**Solution****Ears are sore**

Swift FX Bella Gray headgear is not fitted correctly.

Readjust the straps to ensure they are not overtightened or twisted. If problem persists talk to your clinician.

Swift FX Bella Gray headgear is not suited for your ear type.

Replace the Swift FX Bella Gray headgear with the supplied Swift FX headgear.

Technical specifications**Pressure-flow curve**

The mask contains passive venting to protect against rebreathing. As a result of manufacturing variations, the vent flow rate may vary.

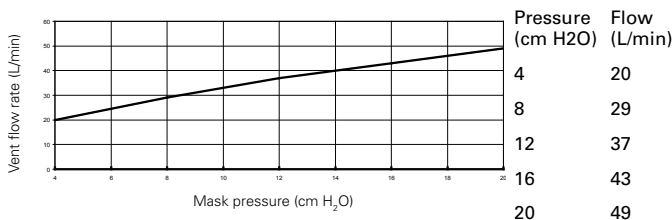
**Dead space information**

Physical dead space is the empty volume of the mask to the end of the swivel. Using the large cushions it is 106 mL.

Therapy pressure

4 to 20 cm H₂O

Resistance

Drop in pressure measured (nominal)
 at 50 L/min: 0.4 cm H₂O
 at 100 L/min: 1.4 cm H₂O

Environmental conditions

Operating temperature: +41°F to 104°F
 (+5°C to +40°C)
 Operating humidity: 15% to 95% relative humidity non-condensing
 Storage and transport temperature: -4°F to 140°F
 (-20°C to +60°C)
 Storage and transport humidity: up to 95% relative humidity non-condensing

Technical specifications

Gross dimensions Large: 16.34" (H) x 3.70" (W) x 1.77" (D)
(415 mm (H) x 94 mm (W) x 45 mm (D))
Mask fully assembled with short tube assembly (no headgear)

Mask setting options **For S9:** Select 'Pillows'
For other devices: Select 'SWIFT' (if available), otherwise select 'MIRAGE' as the mask option.

Notes:

- The mask system does not contain PVC, DEHP or phthalates.
- This product does not contain natural rubber latex.
- The manufacturer reserves the right to change these specifications without notice.













Storage

Ensure that the mask is thoroughly clean and dry before storing it for any length of time. Store the mask in a dry place out of direct sunlight.

Disposal

The mask does not contain any hazardous substances and may be disposed of with your normal household refuse.

Symbols

 Caution, consult accompanying documents;  Batch code;
 Catalogue number;  Temperature limitation;  Humidity limitation;
 Does not contain natural rubber latex;  Manufacturer;  Indicates a Warning or Caution and alerts you to a possible injury or explains special measures for the safe and effective use of the device;  Keep away from rain;
 This way up;  Fragile, handle with care;  European Authorized Representative;  Rx Prescription only (In the US, Federal law restricts these devices to sale by or on the order of a physician.)

Limited warranty

ResMed Ltd (hereafter 'ResMed') warrants that your ResMed mask system (including mask frame, cushion, headgear and tubing) shall be free from defects in material and workmanship from the date of purchase for the period of 90 days or in the case of disposable masks the maximum use period.

This warranty is only available to the initial consumer. It is not transferable.

If the product fails under conditions of normal use, ResMed will repair or replace, at its option, the defective product or any of its components.

This limited warranty does not cover: a) any damage caused as a result of improper use, abuse, modification or alteration of the product; b) repairs carried out by any service organization that has not been expressly authorized by ResMed to perform such repairs; and c) any damage or contamination due to cigarette, pipe, cigar or other smoke. Warranty is void on product sold, or resold, outside the region of original purchase.

Warranty claims on defective product must be made by the initial consumer at the point of purchase.

This warranty replaces all other expressed or implied warranties, including any implied warranty of merchantability or fitness for a particular purpose. Some regions or states do not allow limitations on how long an implied warranty lasts, so the above limitation may not apply to you.

ResMed shall not be responsible for any incidental or consequential damages claimed to have resulted from the sale, installation or use of any ResMed product. Some regions or states do not allow the exclusion or limitation of incidental or consequential damages, so the above limitation may not apply to you.

This warranty gives you specific legal rights, and you may also have other rights which vary from region to region. For further information on your warranty rights, contact your local ResMed dealer or ResMed office.



Manufacturer:

ResMed Ltd 1 Elizabeth Macarthur Drive Bella Vista NSW 2153 Australia.

See www.resmed.com for other ResMed locations worldwide.

For patent information, see www.resmed.com/ip.

Swift is a trademark of ResMed Ltd and is registered in U.S. Patent and Trademark Office.

© 2017 ResMed Ltd.





618257/2 2017-09

Swift FX Bella Gray +
Swift FX Headgear

USER

AMER MUL



618257

Swift™ FX Bella Gray
NASAL PILLOWS SYSTEM